

BEÉPÍTÉSI PÉLDA M= 1:20

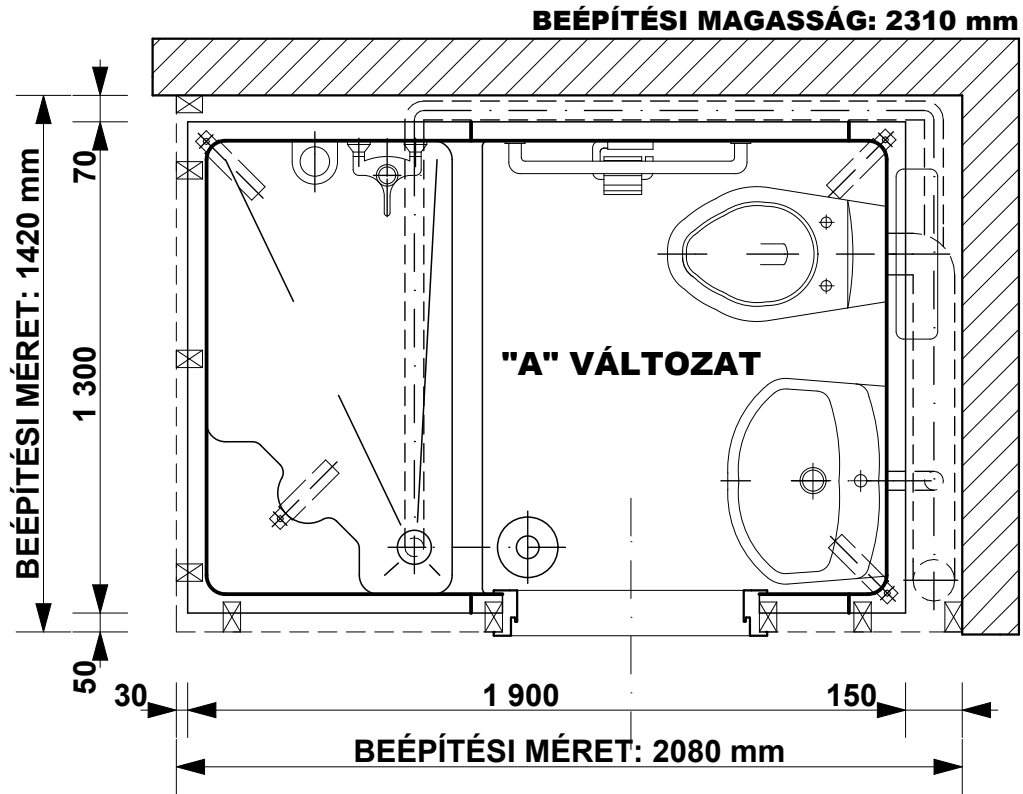

ALAPRAJZI VÁLTOZATOK ÉS BEÉPÍTÉSI MÉRETEK M= 1:50

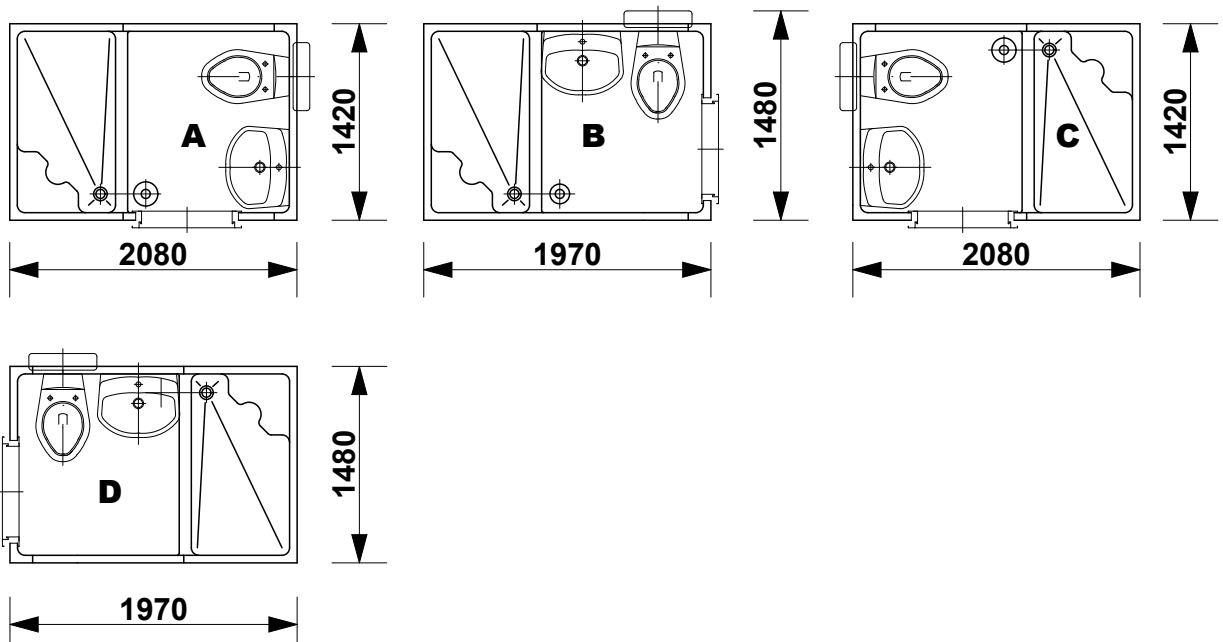



SANSYSTEM

Típus: "DETMOLD"

Sanipex Hungaria Kft. 2600 Vác, Szent László út 50.

M= 1:20

Beépítési méretek

Oldal: 02

CSATLAKOZÁSI MÉRETEK M= 1:20

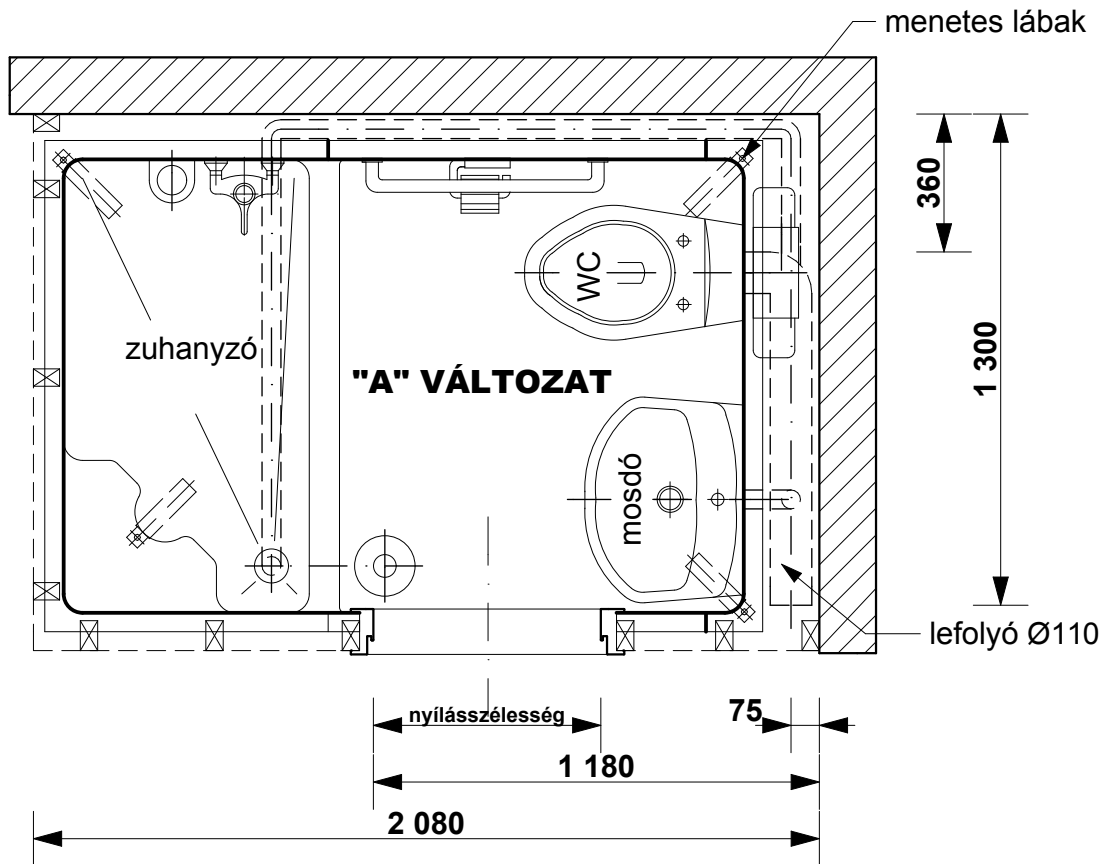

ALAPRAJZI MÉRETEK M= 1:20

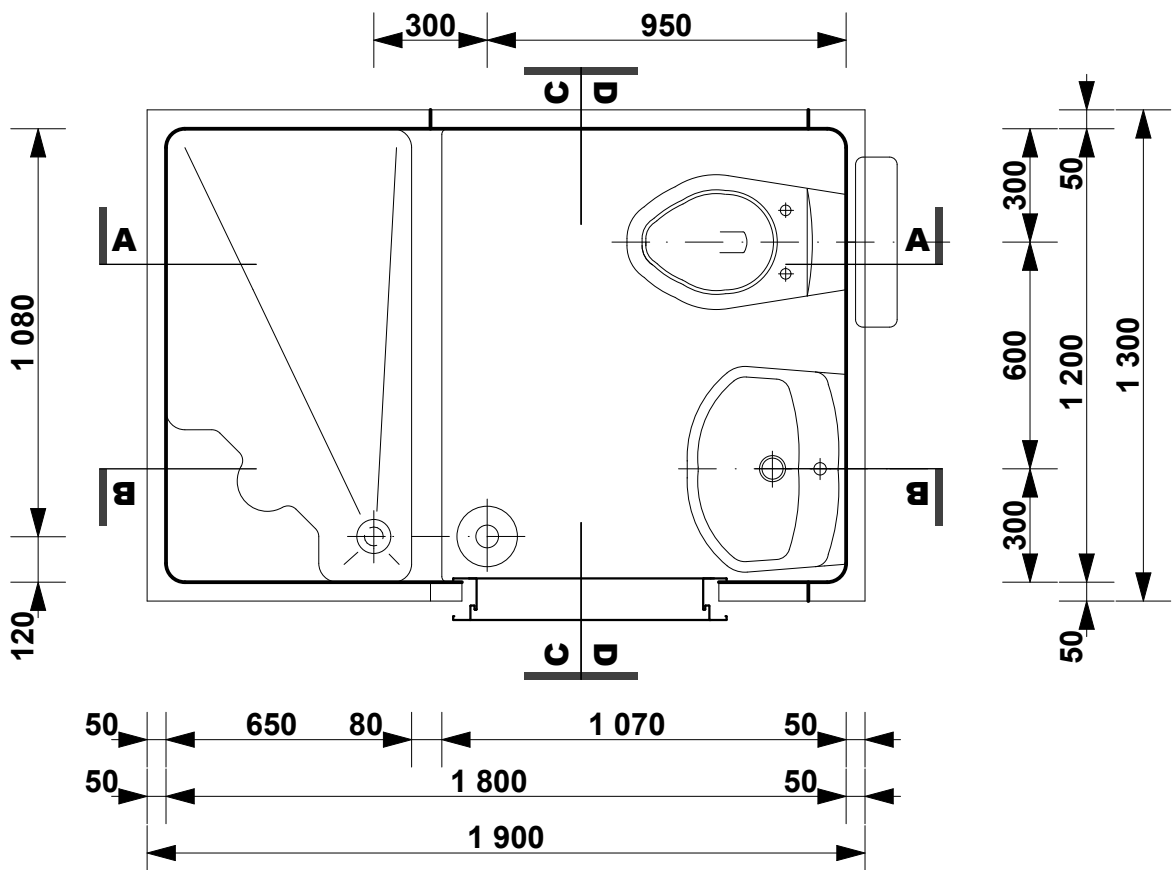



SANSYSTEM

Típus: "DETMOLD"

Sanipex Hungaria Kft. 2600 Vác, Szent László út 50.

M= 1:20

Beépítési méretek

Oldal: 03

A-A METSZET M= 1:20

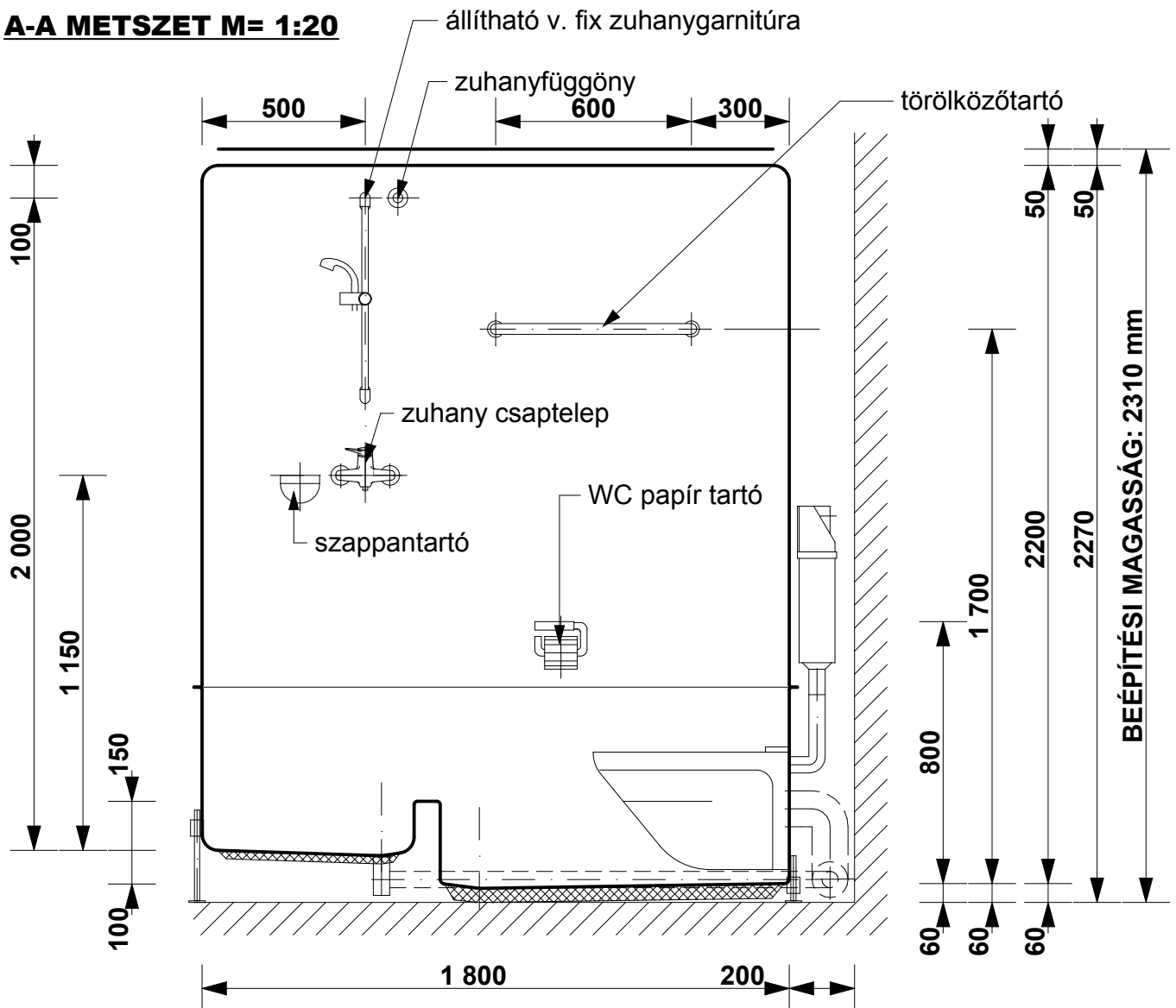

B-B METSZET M= 1:20

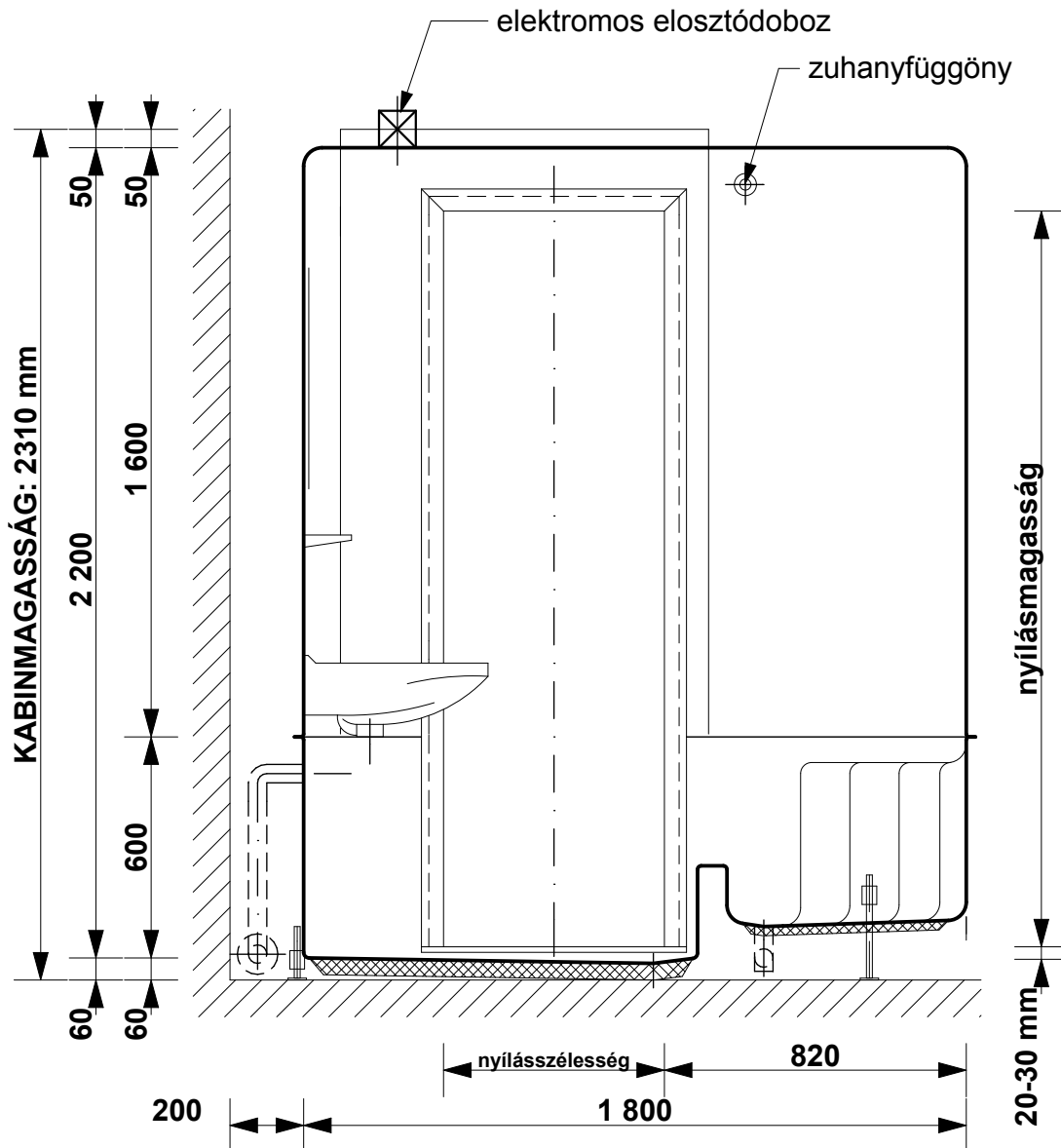



C-C METSZET M= 1:20

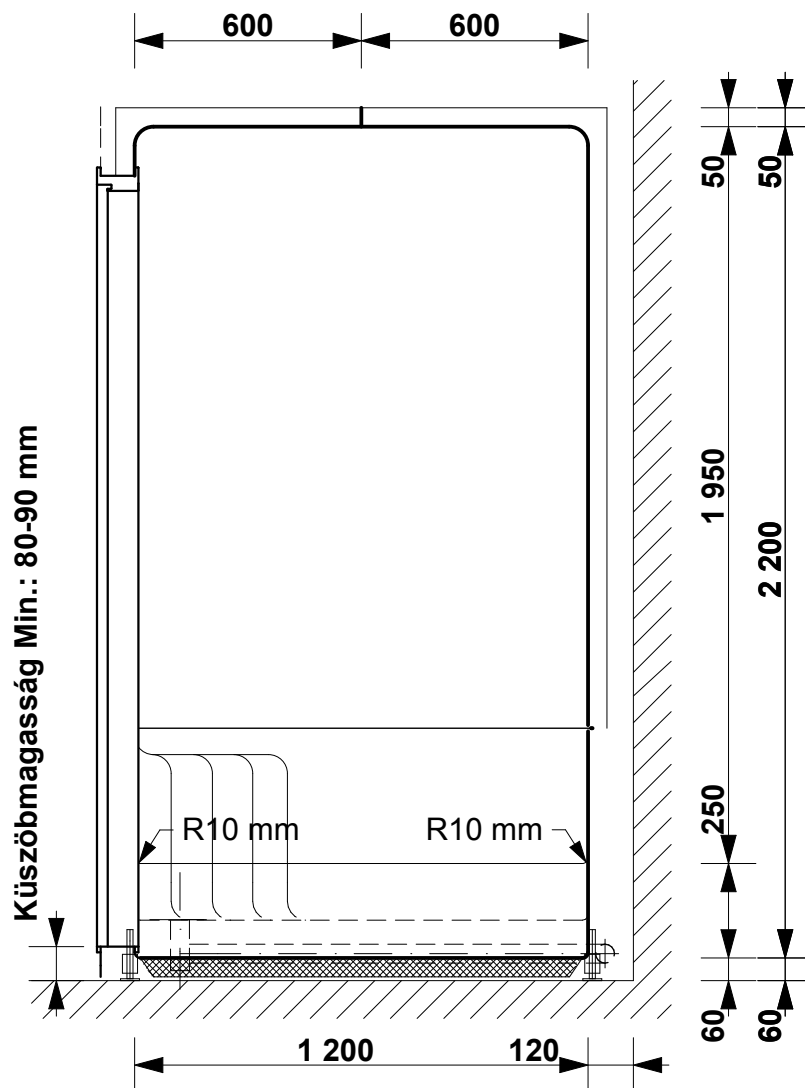

D-D METSZET M= 1:20

